

Triflex prodetail®

Sketch Details

Upright with chase

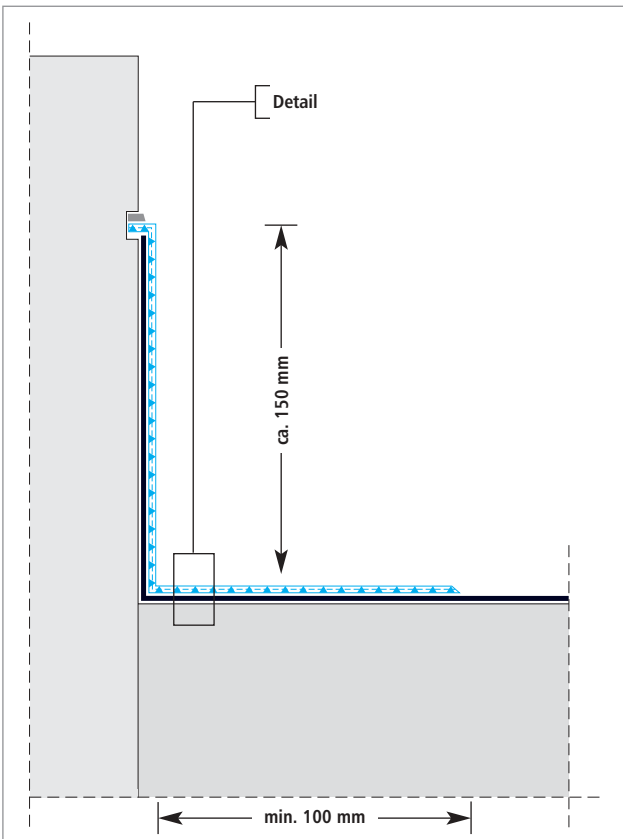

Detail interface

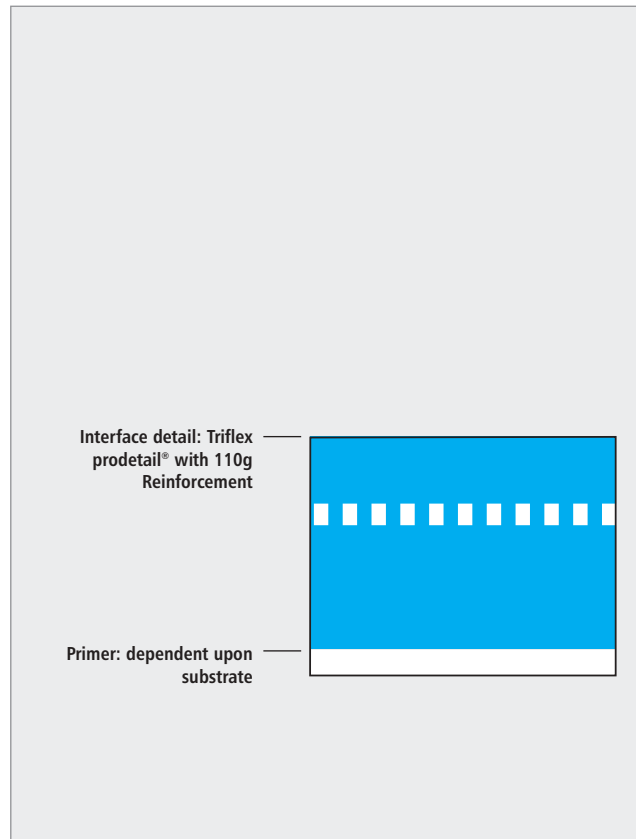

Upright with cover flashing

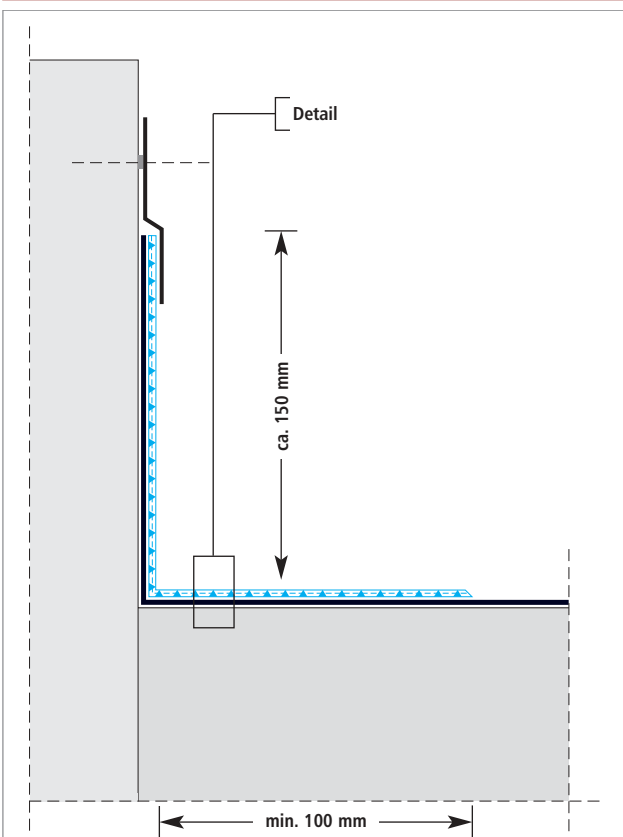

Parapet with capping

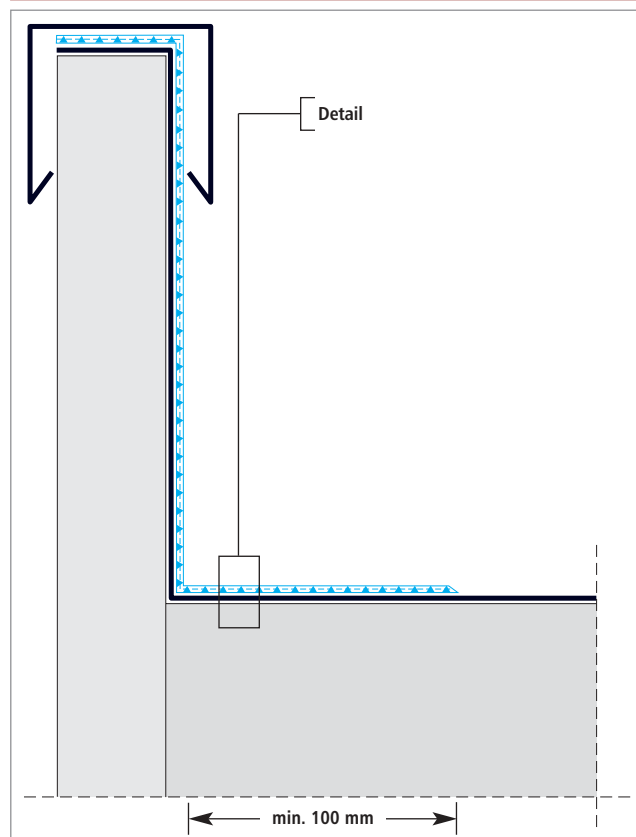

Triflex prodetail®

Sketch Details

Parapet over capping

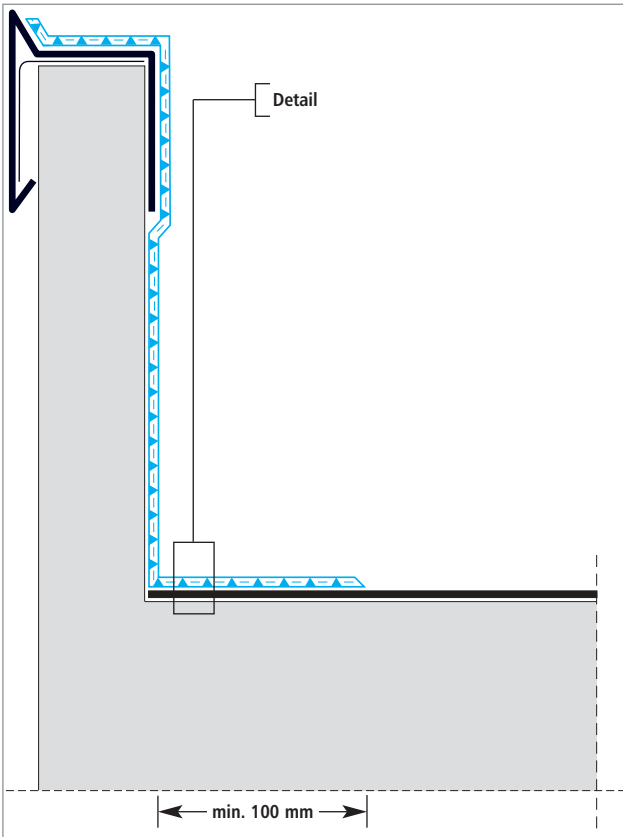

Detail interface

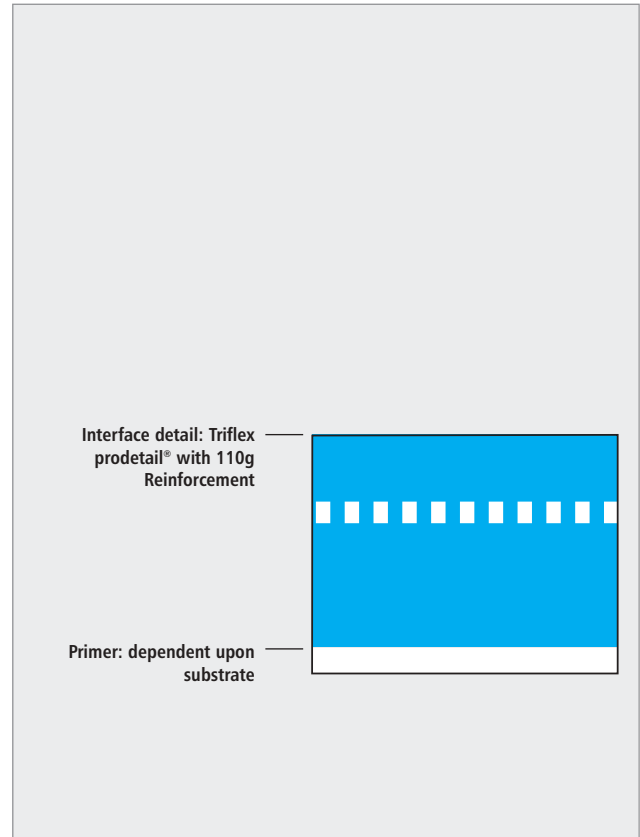

Roof penetration

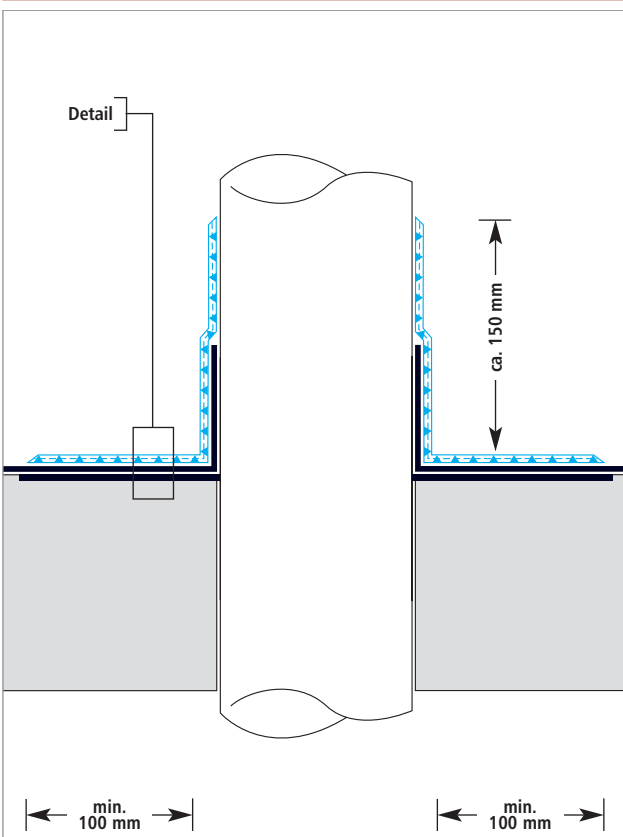

Surface mounted detail

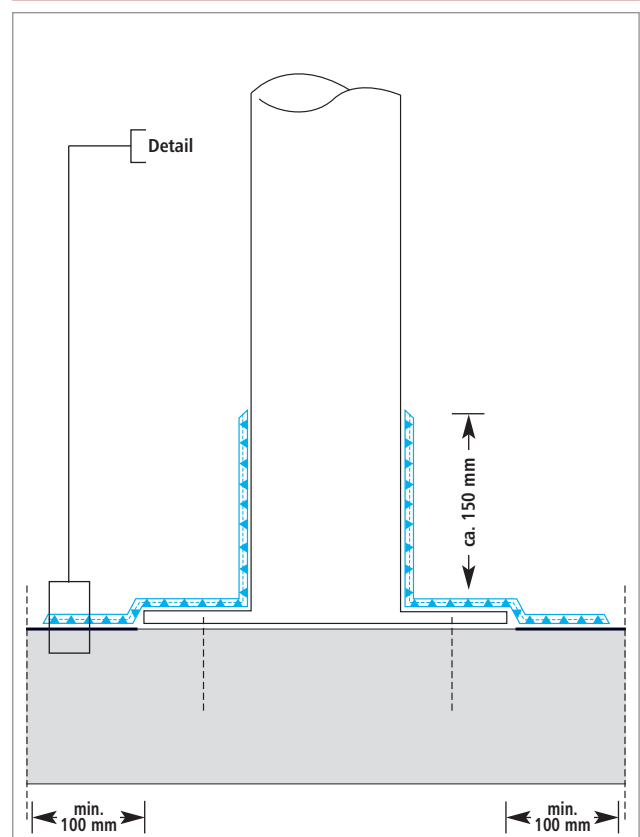

Triflex prodetail®

Sketch Details

Roof outlet

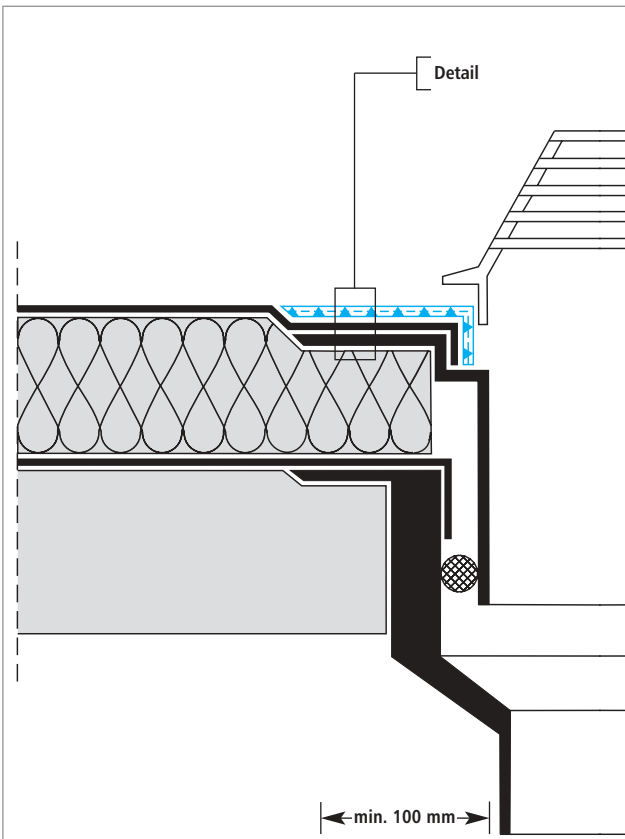

Detail interface

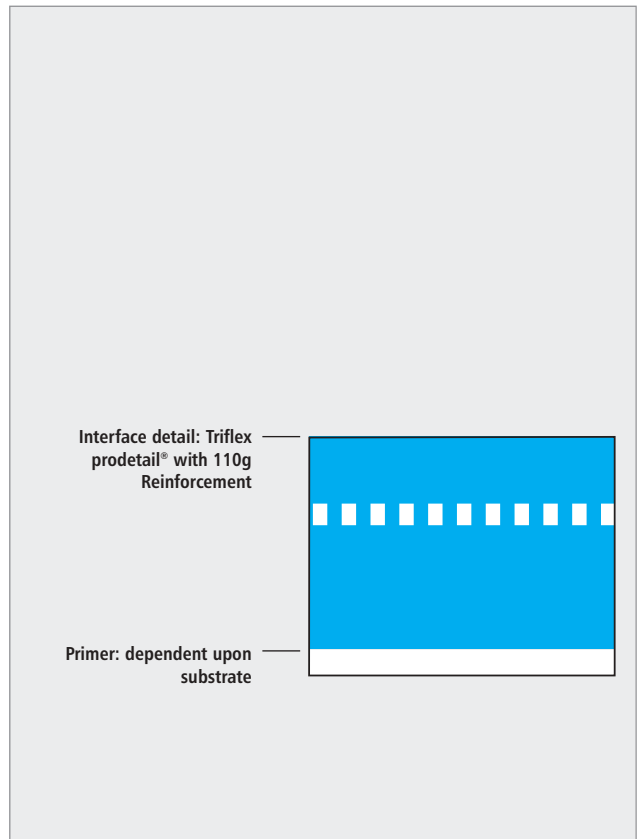

Roof gully

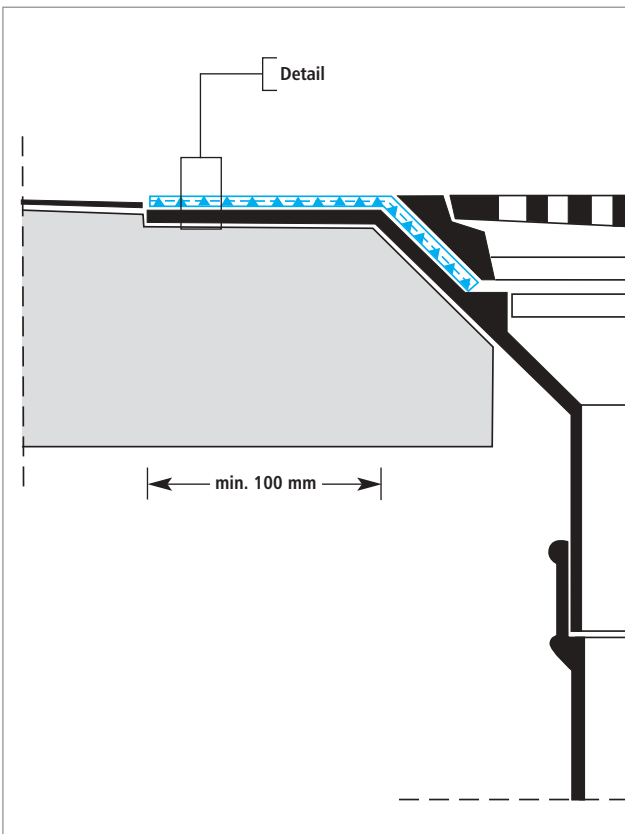

Drip to external gutter

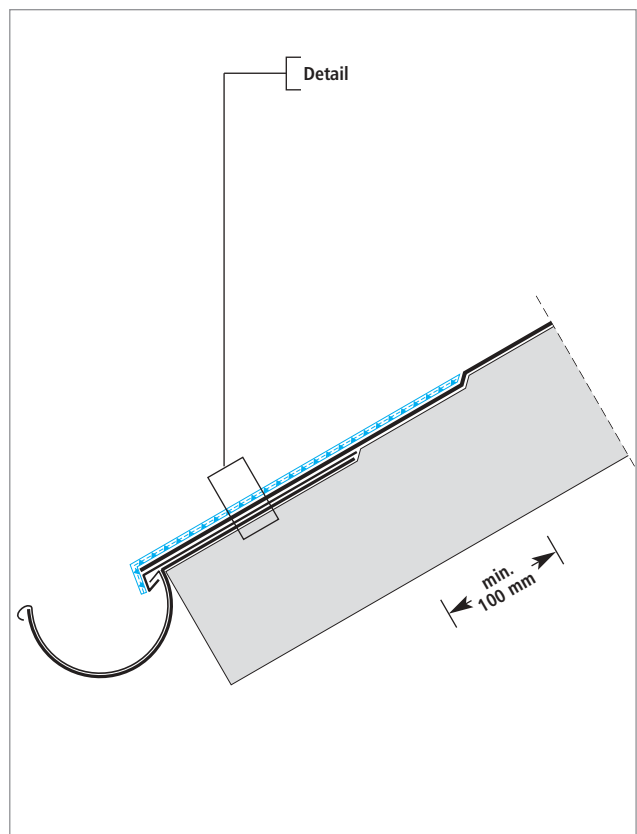

Triflex prodetail®

Sketch Details

Check kerb to roof edge

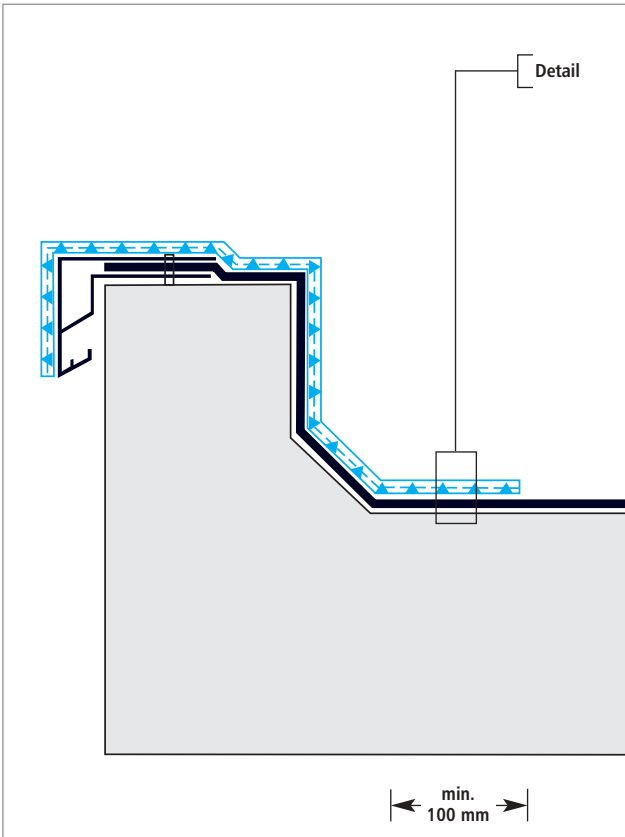

Detail interface

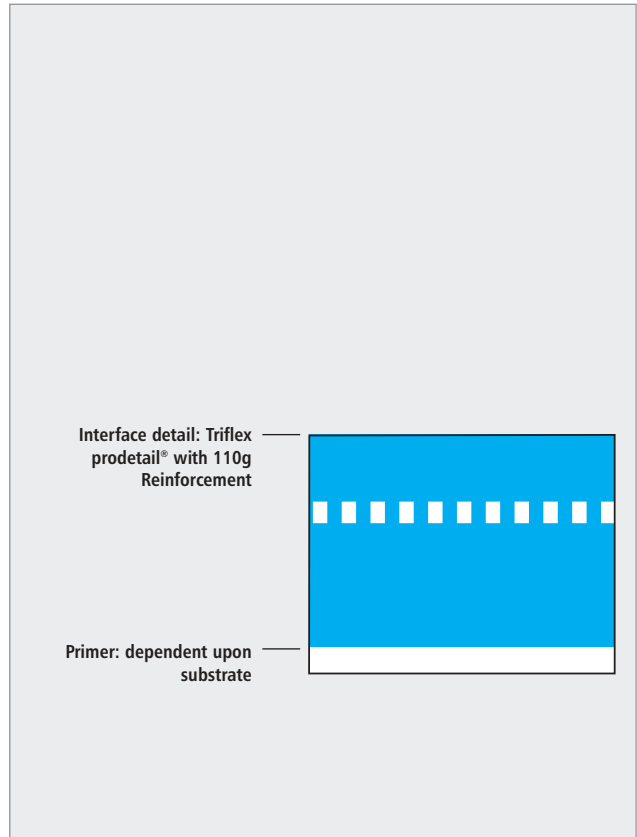

Rooflight

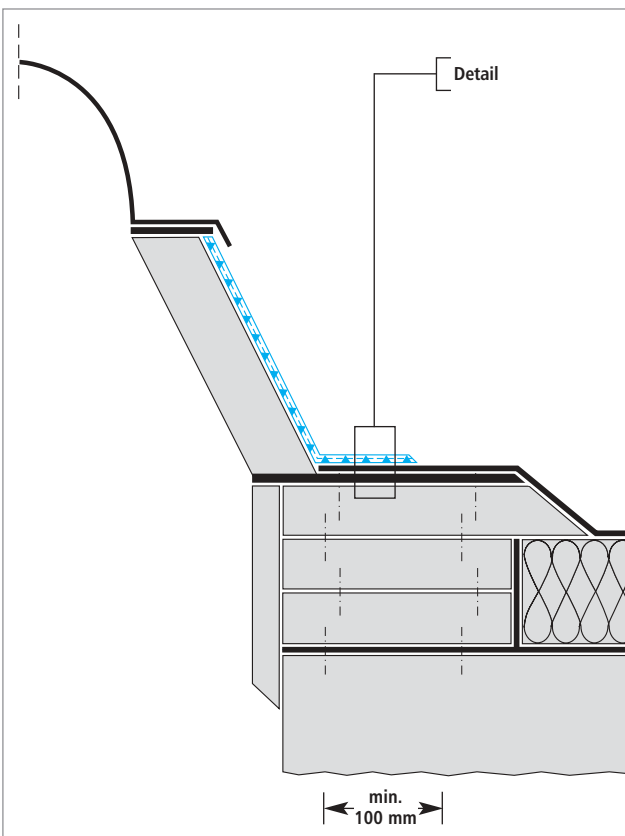

Rooflight with upstand

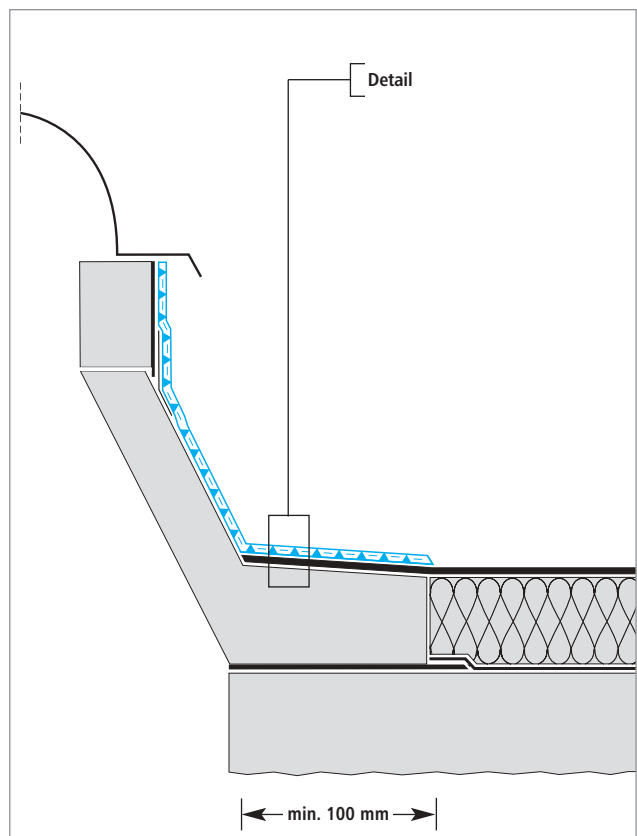

Triflex prodetail®

Sketch Details

Twin kerb expansion joint

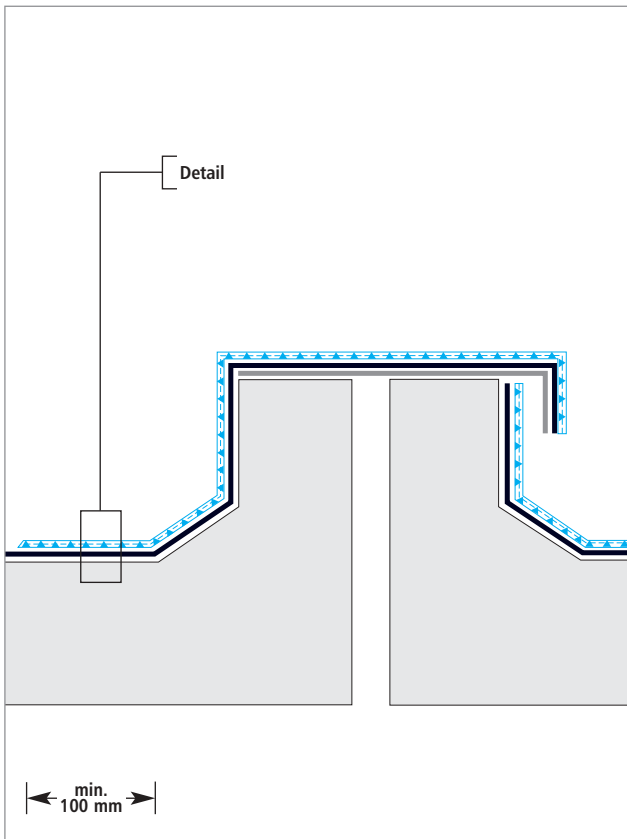

Detail interface

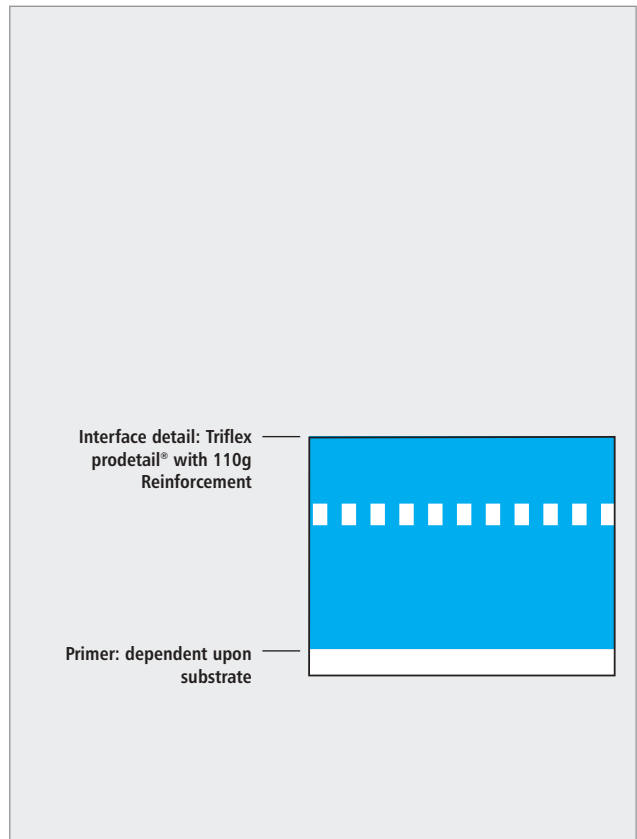

Raised expansion joint

